

WESAN WP G

WOLTMAN METER

DIEHL
Metering



APPLICATION

WESAN WP G is a bulk water meter designed for measuring volumes of cold water (up to 50°C) in supply lines with high flow at low pressure loss.

Modular, WESAN WP G DN50 to DN300 can be fitted at any time with an IZAR clip-on module converting it into a communicating meter ready for mobile or fixed network (radio/wired) reading.

The measuring chamber can be replaced without removing the meter from the pipe.

FEATURES

- ▶ DN50/65/80/100/125/150/200/250/300
- ▶ Q3=40m³/h (DN50) / Q3=63m³/h (DN65) / Q3=100m³/h (DN80) / Q3=160m³/h (DN100/125) / Q3=250m³/h (DN150/200) / Q3=1,000m³/h (DN250) / Q3=1,600m³/h (DN300)
- ▶ MID approval up to R=100
- ▶ For horizontal and vertical installation
- ▶ Calibratable and exchangeable measuring insert
- ▶ Sealed measuring insert for better accuracy
- ▶ Encapsulated and rotating glass/copper register, IP 68
- ▶ Hydraulic bearing relief
- ▶ Protection against magnetic fraud

WESAN WP G

WOLTMAN METER

GENERAL

WESAN WP G		
Medium temperature range	°C	1 ... 30
Temperature safety	°C	1 ... 50
Ambient operating temperature	°C	1 ... 55
Ambient storage temperature	°C	1 ... 55
Nominal pressure	PN bar	16 ¹
Protection class		IP 68

¹ special versions on request

TECHNICAL DATA

Nominal diameter	DN	mm	50	65	80	100	125
Permanent flow rate	Q ₃	m ³ /h	40	63	100	160	160
Starting flow rate		l/h	90	130	160	190	190
Minimum flow rate	Q ₁	m ³ /h	0.63	1.26	1	1.6	1.6
Transitional flow rate	Q ₂	m ³ /h	1.02	2.02	1.6	2.56	2.56
Overload flow rate	Q ₄	m ³ /h	50	78.75	125	200	200
Flow rate at 0.1 bar pressure loss		m ³ /h	29	50	95	95	95
Pressure loss at Q ₃		bar	0.19	0.16	0.14	0.28	0.29

Nominal diameter	DN	mm	150	200	250 ²	300 ²
Permanent flow rate	Q ₃	m ³ /h	250	250	1,000	1,600
Starting flow rate		l/h	1,500	2,500	5,000	10,000
Minimum flow rate	Q ₁	m ³ /h	5	5	10	16
Transitional flow rate	Q ₂	m ³ /h	8	8	16	25.6
Overload flow rate	Q ₄	m ³ /h	312.5	312.5	1,250	2,000
Flow rate at 0.1 bar pressure loss		m ³ /h	290	550	800	1,250
Pressure loss at Q ₃		bar	0.08	0.02	0.16	0.16

² only available without approval

APPROVAL

Nominal diameter	DN	mm	50	65	80	100	125
MID (DE-13-MI001-PTB005)			•	•	•	•	•
Dynamic range (Q ₃ /Q ₁)	R ³		63•H	50•H	100	100	100
Sanitary conformity			KTW / W270	KTW / W270	KTW / W270	KTW / W270	KTW / W270

Nominal diameter	DN	mm	150	200	250 ²	300 ²
MID (DE-13-MI001-PTB005)			•	•	-	-
Dynamic range (Q ₃ /Q ₁)	R ³		50	50	100	100
Sanitary conformity			KTW / W270	KTW / W270	KTW / W270	KTW / W270

² only available without approval

³ standard dynamic other dynamics on request

WESAN WP G

WOLTMAN METER

DISPLAY RANGE

Nominal diameter	DN	mm	50	65	80	100	125
0.5 l ... 999,999 m ³			•	•	•	•	•
5.0 l ... 9,999,999 m ³			-	-	-	-	-
50 l ... 99,999,999 m ³			-	-	-	-	-

Nominal diameter	DN	mm	150	200	250 ²	300 ²
0.5 l ... 999,999 m ³			-	-	-	-
5.0 l ... 9,999,999 m ³			•	•	•	•
50 l ... 99,999,999 m ³			-	-	-	-

² only available without approval

WESAN WP G

WOLTMAN METER

DIMENSIONS

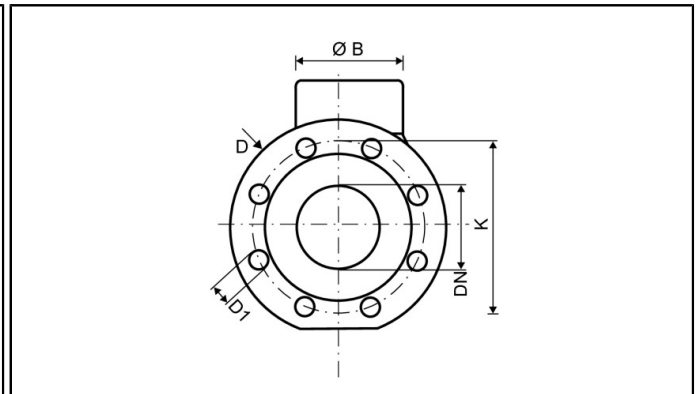
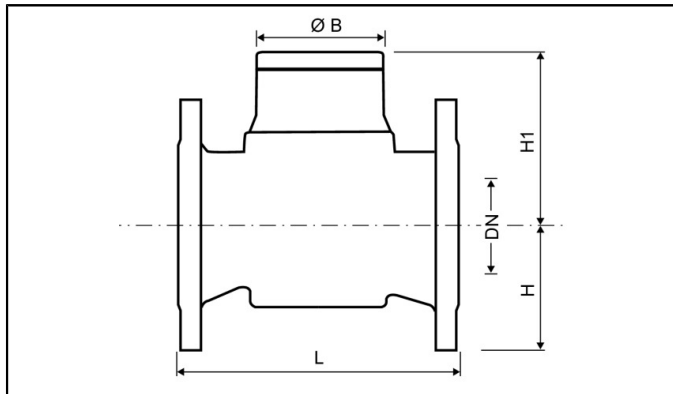

Nominal diameter	DN	mm	50	65	80	100	125
Overall length	L	mm	200 / 300	200	200 ⁴ / 225 / 350 ⁴	250 / 350 ⁴	250
Flange diameter	D	mm	165	185	200	220	250
Hole circle diameter PN 10 / PN 16	K	mm	- / 125	- / 145	160 / 160	- / 180	- / 210
Number of screwholes PN 10 / PN 16		pcs	- / 4	- / 4	4 / 8	- / 8	- / 8
Screwhole diameter PN 10 / PN 16	D1	mm	- / 18	- / 18	18 / 18	- / 18	- / 18
Height	H	mm	75	83	89	105	115
Height	H1	mm	103	103	134	134	134
Height to remove measuring insert		mm	205	205	255	255	255
Meter width		mm	155	155	200	220	250
Diameter	Ø B	mm	110	110	110	110	110
Weight		kg	10.2	11.2	13	16	21.5

Nominal diameter	DN	mm	150	200	250 ²	300 ²
Overall length	L	mm	300	350	450	500
Flange diameter	D	mm	285	340	405	460
Hole circle diameter PN 10 / PN 16	K	mm	- / 240	295 / 295	350 / 355	400 / 410
Number of screwholes PN 10 / PN 16		pcs	- / 8	8 / 12	12 / 12	12 / 12
Screwhole diameter PN 10 / PN 16	D1	mm	- / 22	22 / 22	23 / 27	23 / 27
Height	H	mm	135	163	193	230
Height	H1	mm	225	225	222	270
Height to remove measuring insert		mm	255	455	452	500
Meter width		mm	285	340	405	460
Diameter	Ø B	mm	110	110	110	110
Weight		kg	39	47	75	165

² only available without approval

⁴ special body lengths on request

WESAN WP G

WOLTMAN METER

PRESSURE LOSS GRAPH / TYPICAL ERROR GRAPH

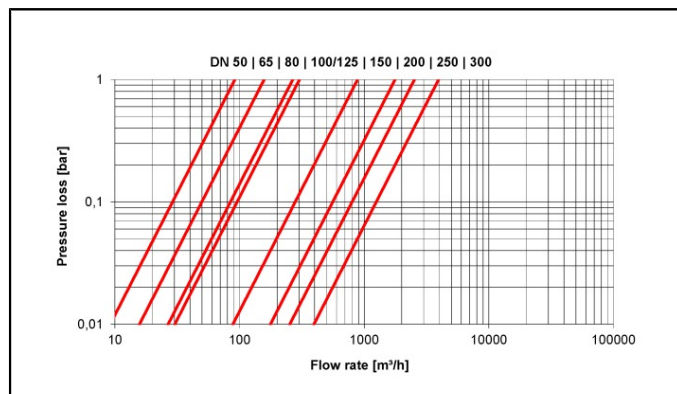

Pressure loss graph

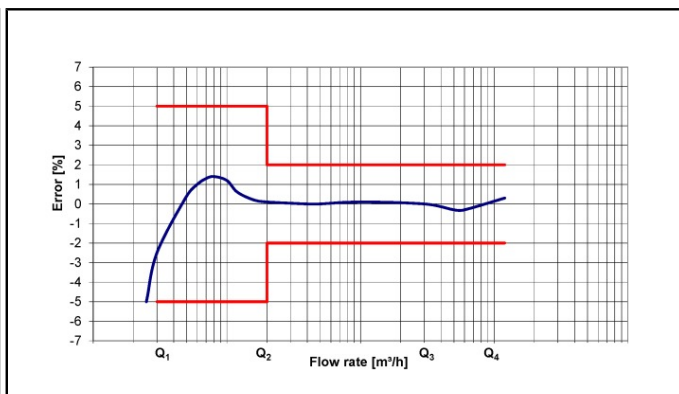

Typical error graph